

GS 50

Cam Kanal Sistem Küpeşte Aksesurları

Glass Railing System Accessories

Аксесуары поручней стеклянной канальной системы

أنواع جي اي من أكسسوارات قنوات الزجاج في نظام الدرابزين

- Cam Taşıyıcı Aksesuarları
- Dirsek ve Dönüş Bağlantıları
- Tapa ve Dekorlu Tapaları
- Profil Duvar Bağlantıları
- Mafsal Bağlantıları
- Profil Bağlantı Bilezikleri
- Cam Tutamakları ve Spider Bağlantıları





 <p>07 101001</p>	<p>GS 10-01</p> <p>Zemin Üstü Cam Kanal Profili (15 cm) (Çift Taraflı Sıkma)</p> <p>Above Ground Glass Channel Profile (15 cm)</p> <p>Надземный Стекланный канальный профиль (15 см)</p> <p>شكل قناة زجاج فوق الأرض (15 سم)</p>	 <p>07 110011</p>	<p>GS 10-01-1</p> <p>Zemin Üstü Cam Kanal Profili (20 cm)</p> <p>Above Ground Glass Channel Profile (20 cm)</p> <p>Надземный Стекланный канальный профиль (20 см)</p> <p>شكل قناة زجاج فوق الأرض (20 سم)</p>	 <p>07 110012</p>	<p>GS 10-01-2</p> <p>Zemin Üstü Cam Kanal Profili (15 cm) (Tek Taraflı Sıkma)</p> <p>Above Ground Glass Channel Profile (15 cm)</p> <p>Надземный Стекланный канальный профиль (15 см)</p> <p>شكل قناة زجاج فوق الأرض (15 سم)</p>
 <p>07 110013</p>	<p>GS 10-01-3</p> <p>Zemin Üstü Cam Kanal Profili (20 cm) (Tek Taraflı Sıkma)</p> <p>Above Ground Glass Channel Profile (20 cm)</p> <p>Надземный Стекланный канальный профиль (20 см)</p> <p>شكل قناة زجاج فوق الأرض (20 سم)</p>	 <p>07 110014</p>	<p>GS 10-01-4</p> <p>Cam Yatağı Takımı 15 cm (10-12 mm Cam)</p> <p>Base Kit 15 cm (10-12 mm Cam)</p> <p>Комплект Нижнего Стеклодержателя 15 см (10-12мм Стекло)</p> <p>طقم قاعدي طول 15 سم لزجاج 10 - 12 مم</p>	 <p>07 110015</p>	<p>GS 10-01-5</p> <p>Cam Yatağı Takımı 30 cm (10-12 mm Cam)</p> <p>Base Kit 30 cm (10-12 mm Cam)</p> <p>Комплект Нижнего Стеклодержателя 30см (10-12мм Стекло)</p> <p>طقم قاعدي طول 30 سم لزجاج 10 - 12 مم</p>
 <p>07 101002</p>	<p>GS 10-02</p> <p>Zemin Altı Cam Kanal Profili (15 cm)</p> <p>Underground Glass Channel Profile (15 cm)</p> <p>под настилом Стекланный канальный профиль (15 см)</p> <p>شكل قناة زجاج تحت الأرض (15 سم)</p>	 <p>07 110021</p>	<p>GS 10-02-1</p> <p>Zemin Altı Cam Kanal Profili (20 cm)</p> <p>Underground Built-in Glass Channel Profile (20 cm)</p> <p>под настилом Стекланный канальный профиль (20 см)</p> <p>شكل قناة زجاج تحت الأرض (20 سم)</p>	 <p>07 110022</p>	<p>GS 10-02-2</p> <p>Yandan Bağlantılı Cam Kanal Profili (15 Cm)</p> <p>Side mount glass Channel Profile (15 cm)</p> <p>Боковые стекла крепление профиль канала (15 см)</p> <p>شكل قناة زجاج بواسطة من الجانب (15)</p>
 <p>07 110023</p>	<p>GS 10-02-3</p> <p>Yandan Bağlantılı Cam Kanal Profili (20 Cm)</p> <p>Side mount glass Channel Profile (20 cm)</p> <p>Боковые стекла крепление профиль канала (20 см)</p> <p>شكل قناة زجاج بواسطة من الجانب (20)</p>	 <p>07 110024</p>	<p>GS 10-02-4</p> <p>Zemin Üstü Cam Kanal Profili (1 mt)</p> <p>Above Ground Glass Channel Profile (1 mt)</p> <p>Надземный Стекланный канальный профиль (1 mt)</p> <p>مقطع قنوات الزجاج فوق الارضية (1متر)</p>	 <p>07 101003</p>	<p>GS 10-03</p> <p>Cam Korkuluk Yandan Bağlantı Takımı (10 mm)</p> <p>Glass Railing Sideways Connection Kit</p> <p>комплект Бокового соединения стеклянных поручней</p> <p>طقم واصلة من الجانب درابزين زجاج</p>



	GS 10-04
	Zemin Üstü Cam Kanal Profil Kapağı (1 mt) (3623 için)
	Above Ground Glass Channel Profile Cover (1 m)
	Надземная Заглушка стеклянного канального профиля (1 м)
07 101004	غطاء قناة زجاج فوق الأرض (1متر)

	GS 10-05
	Zemin Altı Cam Kanal Profil Kapağı (1 mt)
	Underground Glass Channel Profile Cover (1 m)
	Подземная Заглушка стеклянного канального профиля (1 м)
07 101005	غطاء قناة زجاج تحت الأرض (1متر)

	GS 10-05-1
	Yandan Bağlantı Cam Kanal Profil Kapağı (1 mt)
	Above Ground Glass Channel Profile Cover (1 m)
	Надземная Заглушка стеклянного канального профиля (1 м)
07 110051	غطاء قناة زجاج واصله من الجانب (1متر)

	GS 10-05-2
	Zemin Üstü Cam Kanal Profil Kapağı (1 Mt)
	Above Ground Glass Channel Profile Cover (1 m)
	Надземная Заглушка стеклянного канального профиля (1 м)
07 110052	غطاء قناة زجاج واصله من الجانب (1متر)

	GS 10-06
	Cam Kanalı Ray Profili (1 mt)
	Glass Channel Rail Profile (1 m)
	стеклянный канальный профиль рельса (1 м)
07 101006	شكل مجري قناة زجاج (1متر)

	GS 10-06-1
	Zemin Altı Cam Kanal Profil Rayı (1 Mt)
	Glass Channel Rail Profile (1 m)
	стеклянный канальный профиль рельса (1 м)
07 110061	مجري شكل قناة زجاج تحت الأرض (1متر)

	GS 10-06-2
	Cam Yatağı Kapağı Küçük Düz (GS 10-01-4 için)
	Square Small Base Profile Cover
	Накладка Для Нижнего Стеклодержателя Прямой
07 110062	غطاء للطبقم القاعدي

	GS 10-06-3
	Cam Yatağı Kapağı Küçük Elips (GS 10-01-4 için)
	Ellipse Small Base Profile Cover
	Накладка Для Нижнего Стеклодержателя Эллипс
07 110063	غطاء بيضوي للطبقم القاعدي

	GS 10-07
	EPDM Conta DCF 30
	EPDM Gasket DCF 30
	EPDM Уплатнитель DCF 30
03 010503	فتيل خارجي للزجاج

	GS 10-07-1
	EPDM Conta İCF 30
	EPDM Gasket İCF 30
	EPDM Уплатнитель İCF 30
03 011230	فتيل خارجي للزجاج

	GS 10-07-2
	EPDM Conta 6611, 7311, 3809 Nolu Profiller için 16 mm Conta
	EPDM Gasket (U Shaped 16 mm Glass For 6611,7311,3809)
	EPDM U Уплатнитель На 16 мм Для 6611,7311,3809 Профилей
03 070116	فتيل بشكل حرف U للزجاج بسماكة 16 مم

	GS 10-07-3
	EPDM Conta Kıp. 18
	EPDM Gasket Kıp.18
	EPDM Уплатнитель Kıp.18
03 010652	فتيل بشكل حرف L لتوصع الزجاج



 <p>07 110074</p>	<p>GS 10-07-4</p> <p>Cam Kanal Profil Contası</p> <p>Glass Channel Profile Gasket</p> <p>Уплотнитель стеклянного канального профиля</p> <p>واصله خارجية قناة زجاج</p>	 <p>03 070121</p>	<p>GS 10-07-5</p> <p>EPDM Conta 1641 U Conta 6610 Nolu Profil 16 mm Cam için</p> <p>EPDM Gasket (U Shaped 16 mm Glass For 1641 6610)</p> <p>EPDM U 1641 Уплотнитель На 16мм Для 6610 Профиля</p> <p>فتيل بشكل حرف U للزجاج بسماكة 16 مم</p>	 <p>03 010653</p>	<p>GS 10-07-6</p> <p>EPDM Conta Küp. 20</p> <p>EPDM Gasket Kup.20</p> <p>EPDM Уплотнитель Küp.20</p> <p>فتيل لضغط الزجاج</p>
 <p>07 110078</p>	<p>GS 10-07-8</p> <p>12 mm Cam Fiteli Dış (1 mt) (GS 10-06-2 Profili için)</p> <p>12 mm Glazing Gasket Outer (1 m)</p> <p>Наружный фитиль для стекла 12 мм (1м)</p> <p>(م) فتيل خارجي لزجاج 12مم</p>	 <p>07 110079</p>	<p>GS 10-07-9</p> <p>10 mm Cam Fiteli Dış (1 mt) (GS 10-06-2 Profili için)</p> <p>10 mm Glazing Gasket Outer (1 m)</p> <p>Наружный фитиль для стекла 10 мм (1м)</p> <p>(م) فتيل خارجي لزجاج 10مم</p>	 <p>07 101008</p>	<p>GS 10-08</p> <p>Zemin Üstü Sıkıştırılmalı Cam Tutamağı (10 mm Cam)</p> <p>Glass Railing Sideways Connection Kit</p> <p>комплект Бокового соединения стеклянных поручней</p> <p>مقبض مثبت الزجاج المضغوط فوق الأرض</p>
 <p>07 101009</p>	<p>GS 10-09</p> <p>Zemin Üstü Sıkıştırılmalı Cam Tutamağı</p> <p>Glass Railing Sideways Connection Kit</p> <p>комплект Бокового соединения стеклянных поручней</p> <p>مقبض مثبت الزجاج المضغوط فوق الأرض</p>	 <p>07 101010</p>	<p>GS 10-10</p> <p>Yandan Bağlantılı Sıkıştırılmalı Cam Tutamağı</p> <p>Glass Railing Sideways Connection Kit</p> <p>комплект Бокового соединения стеклянных поручней</p> <p>مقبض رابط الزجاج المضغوط من الزوايا</p>	 <p>07 101011</p>	<p>GS 10-11</p> <p>Zemin Üstü Sıkıştırılmalı Cam Tutamağı</p> <p>Glass Railing Sideways Connection Kit</p> <p>комплект Бокового соединения стеклянных поручней</p> <p>مقبض مثبت الزجاج المضغوط فوق الأرض</p>
 <p>07 101012</p>	<p>GS 10-12</p> <p>Zemin Üstü Spiderli Cam Dikme Takımı</p> <p>Glass Railing Sideways Connection Kit</p> <p>комплект Бокового соединения стеклянных поручней</p> <p>طقم دعامة زجاج عنكبوتی فوق الأرض</p>	 <p>07 101013</p>	<p>GS 10-13</p> <p>Zemin Üstü Sıkıştırılmalı Cam Tutamağı</p> <p>Glass Railing Sideways Connection Kit</p> <p>комплект Бокового соединения стеклянных поручней</p> <p>للدرايزين الزجاجي طقم توصيل جانبي</p>	 <p>07 101014</p>	<p>GS 10-14</p> <p>Yandan Bağlantılı Sıkıştırılmalı Cam Tutamağı</p> <p>Glass Railing Sideways Connection Kit</p> <p>комплект Бокового соединения стеклянных поручней</p> <p>للدرايزين الزجاجي طقم توصيل جانبي</p>

	GS 10-20
	Yandan Düz Cam Tutamağı (12-16-20 mm Cam için)
	Glass Holder from the side (12-16-20 mm Cam)
	Ручка с прямой стеклянной ручкой (12-16-20 мм стекло)
07 101020	مقبض زجاجي مستقيم على الجانب 12-16-20 مم

	GS 10-21
	Zemin Cam Tutamağı Küçük (10-12 mm)
	Base Glass Holder Big (10-12 mm)
	Нижний маленький стеклодержатель (10 - 12мм)
07 101021	مثبت زجاج قاعدي صغير 10-12 مم

	GS 10-22
	Zemin Cam Bağlantı Aparatı Küçük Kare (10 - 12 mm)
	Square Base Glass Holder Small (10-12 mm)
	Квадратный Нижний Маленький Стеклодержатель (10-12мм)
07 101022	مثبت زجاج قاعدي صغير مربع 10-12 مم

	GS 10-23
	Zemin Cam Tutamağı Büyük (16-20 mm)
	Base Glass Holder Big (16-20 mm)
	Нижний большой стеклодержатель (16-20мм)
07 101023	مثبت زجاج قاعدي 16-20 مم

	GS 10-24
	Zemin Cam Tutamağı Büyük (16-20 mm)
	Base Glass Holder Big (16-20 mm)
	Нижний большой стеклодержатель (16-20мм)
07 101024	مثبت زجاج قاعدي 16-20 مم

	GS 10-25
	Çiftli spider cam ayağı kare
	Square double shortleg glass holder
	Квадратная Ножка С Двойным Спадером
07 101025	سبايدر ثنائي مربع على الأرض حامل للزجاج

	GS 10-26
	Çiftli spider cam ayağı
	Round double shortleg glass holder
	Квадратная Ножка С Двойным Спадером
07 101026	سبايدر ثنائي دائري على الأرض حامل للزجاج

	GS 10-27
	Yandan Spider Bağlantısı 35 İik Gövde (8 - 12 mm)
	Lateral Spider Connector 35 mm Diameter (8-12 mm)
	Боковое Крепление Спадера 35 (8-12 mm)
07 101027	(8 - 12 MM زجاج) (35 MM) دبوس زجاجي سبايدر بقطر

	GS 10-28
	Yandan Spider Bağlantısı 50 İik Gövde (16-20 mm)
	Lateral Spider Connection For Glass 50 mm Diameter (16-20 mm)
	Боковое Крепление Спадера 50 (16-20 mm)
07 101028	(16-20 MM زجاج) (50 MM) دبوس زجاجي سبايدر بقطر

	GS 10-29
	Yandan Spider Bağlantısı 50 İik Gövde (Ayarlı) 45 mm Uzunluk (16-20 mm)
	Lateral Spider Connection For Glass 50 mm Diameter (45 mm Length) (16-20 mm)
	Боковое Крепление Спадера 50 Регулируемое 45mm Длинной(16-20 Mm)
07 101029	(16-20 MM الطول) (زجاج 45 MM) دبوس زجاجي سبايدر بقطر (50 MM)

	GS 10-30
	Yandan Spider Bağlantısı 50 İik Gövde (Ayarlı) 25 mm Uzunluk (16-20 mm)
	Lateral Spider Connection For Glass 50 mm Diameter 25 mm Length (16-20 mm)
	Боковое Крепление Спадера 50 Регулируемое 25mm Длинной(16-20 Mm)
07 101030	(16-20 MM الطول) (زجاج 25 MM) دبوس زجاجي سبايدر بقطر (50 MM)

	GS 10-31
	Kare Yandan Cam Bağlantı Aparatı (8 - 12 mm)
	Lateral Square Glass Connector (8 - 12 mm)
	Боковой Апарат Крепления Квадратный(8-12 Mm)
07 101031	سبايدر (زجاج 8 - 12 MM) دبوس زجاجي مربع



<p>07 101101</p>	<p>GS 11-01</p> <p>Cam Spider Bağlantı Mafsalı (Hareketli)</p> <p>Glass Spider with Connection Joint (Movable)</p> <p>соединительный шарнир Spider (подвижный)</p> <p>مفصل واصلة عنكبوتی زجاج (متحرك)</p>	<p>07 101102</p>	<p>GS 11-02</p> <p>Cam Spider Bağlantı Mafsalı (Hareketli)</p> <p>Glass Spider with Connection Joint (Movable)</p> <p>соединительный шарнир Spider (подвижный)</p> <p>مفصل واصلة عنكبوتی زجاج (متحرك)</p>	<p>07 101103</p>	<p>GS 11-03</p> <p>Cam Spider Bağlantı Mafsalı (Sabit)</p> <p>Glass Spider with Connection Joint (Fixed)</p> <p>соединительный шарнир Spider (неподвижный)</p> <p>مفصل واصلة عنكبوتی زجاج (ثابت)</p>
<p>07 101104</p>	<p>GS 11-04</p> <p>Cam Spider Bağlantı Mafsalı (Sabit)</p> <p>Glass Spider with Connection Joint (Fixed)</p> <p>соединительный шарнир Spider (неподвижный)</p> <p>مفصل واصلة عنكبوتی زجاج (ثابت)</p>	<p>07 111041</p>	<p>GS 11-04-1</p> <p>Cam Spider Bağlantı Mafsalı (Sabit)</p> <p>Glass Spider with Connection Joint (Fixed)</p> <p>соединительный шарнир Spider (неподвижный)</p> <p>مفصل واصلة عنكبوتی زجاج (ثابت)</p>	<p>07 111042</p>	<p>GS 11-04-2</p> <p>Cam Spider Bağlantı Mafsalı (Sabit)</p> <p>Glass Spider with Connection Joint (Fixed)</p> <p>соединительный шарнир Spider (неподвижный)</p> <p>مفصل واصلة عنكبوتی زجاج (ثابت)</p>
<p>07 101201</p>	<p>GS 12-01</p> <p>25x60 90 Derece Bilezikli Dönüş Takımı</p> <p>25x60 90° Cornering Kit With Ring</p> <p>25x60 90° поворот поручня</p> <p>طقم دوار بأسوار 90 درجة مئوية 25x60</p>	<p>07 101202</p>	<p>GS 12-02</p> <p>30x80 90° Bilezikli Dönüş Takımı</p> <p>30x80 90° Cornering Kit With Ring</p> <p>30x80 90° поворот поручня</p> <p>طقم انحناء ببقففيص 90 ° مقاس 30x80</p>	<p>07 101203</p>	<p>GS 12-03</p> <p>30x80 90° Bilezikli Dönüş Takımı</p> <p>30x80 90° Cornering Kit With Ring</p> <p>30x80 90° поворот поручня</p> <p>طقم دوار بأسوار 90 درجة مئوية 30x80</p>
<p>07 101204</p>	<p>GS 12-04</p> <p>16 mm U Profil 90° Dönüş Takımı</p> <p>16 mm Profile 90° Corner Connection Kit</p> <p>16 угловое соединение 90° на овальный профиль</p> <p>طقم بتوصيل زاوية 90 ° مقاطع بيضراوي مقاس 16</p>	<p>07 101205</p>	<p>GS 12-05</p> <p>50'lik Kanalı 90° Dönüş Takımı</p> <p>50'lik Profile 90° Corner Connection Kit</p> <p>50 угловое соединение 90° на овальный профиль</p> <p>طقم بتوصيل زاوية 90 ° مقاطع بيضراوي مقاس 50</p>	<p>07 101206</p>	<p>GS 12-06</p> <p>30 x 28 90 Derece Dirsek</p> <p>30 x 28 90° Bend</p> <p>30x28 90° Колено</p> <p>كوع 90° درجة ثابت 30x28</p>



	GS 12-07
	30x28 Duvar Flaşı
	30x28 Wall Flange
	30x28 Боковой Фланец
07 101207	30x28 فلنجة جدارية

	GS 14-01
	50'lik Kanallı Boru Tapası
	Glass Channel Tube Plug of 50
	Заглушка канальная 50
07 101401	سدادة انبوب بقناة قطر 50

	GS 14-02
	Cam Kanal Profil Tapası
	Glass Glass Channel Profile Plug
	Заглушка стеклянного канального профиля
07 101402	صمامات أو سدادات أشكال قنوات الزجاج

	GS 14-02-1
	Yandan Bağlantılı Cam Kanal Profil Tapası
	Glass Channel Profile Plug
	Заглушка стеклянного канального профиля
07 114021	صمامات ربط قنوات الزجاج من الزوايا

	GS 14-02-2
	28x30 U Cam Kanal Profil Tapası (7311 için)
	28x30 U Glass Channel Profile Plug
	28x30 U Профильная заглушка для стеклянного канала
07 114022	صمامات أشكال قنوات الزجاج على شكل U مقاس 28x30

	GS 14-03
	25x60 Cam Kanal Profil Tapası
	25x60 Glass Channel Profile Plug
	25x60 Профильная заглушка для стеклянного канала
07 101403	صمامات أشكال قنوات الزجاج بمقاسات 25x60

	GS 14-04
	30x80 Cam Kanal Profil Tapası
	30x80 Glass Channel Profile Plug
	30x80 Профильная заглушка для стеклянного канала
07 101404	صمامات أشكال قنوات الزجاج بمقاسات 30x80

	GS 14-05
	30x80 Cam Kanal Profil Tapası
	30x80 Glass Channel Profile Plug
	30x80 Профильная заглушка для стеклянного канала
07 101405	صمامات أشكال قنوات الزجاج بمقاسات 30x80

	GS 14-06
	Cam Kanal Profil Tapası
	Above Ground Linead System
	Заглушка стеклянного канального профиля
07 101406	سدادة مقطع قناة ربط الزجاج بالزجاج

	GS 14-07
	Cam Kanal Profil Tapası
	Above Ground Linead System
	Заглушка стеклянного канального профиля
07 101406	سدادة مقطع قناة ربط الزجاج بالزجاج

	GS 14-08
	Cam Kanal Profil Tapası
	Above Ground Linead System
	Заглушка стеклянного канального профиля
07 101408	سدادة مقطع قناة ربط الزجاج بالزجاج

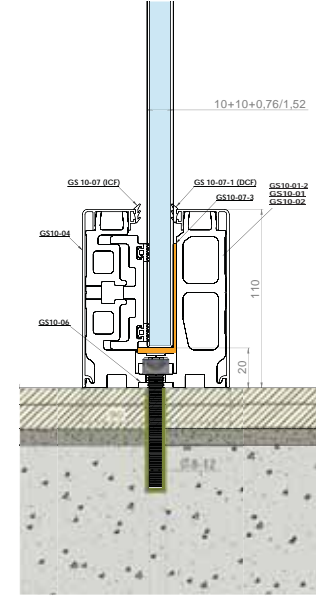
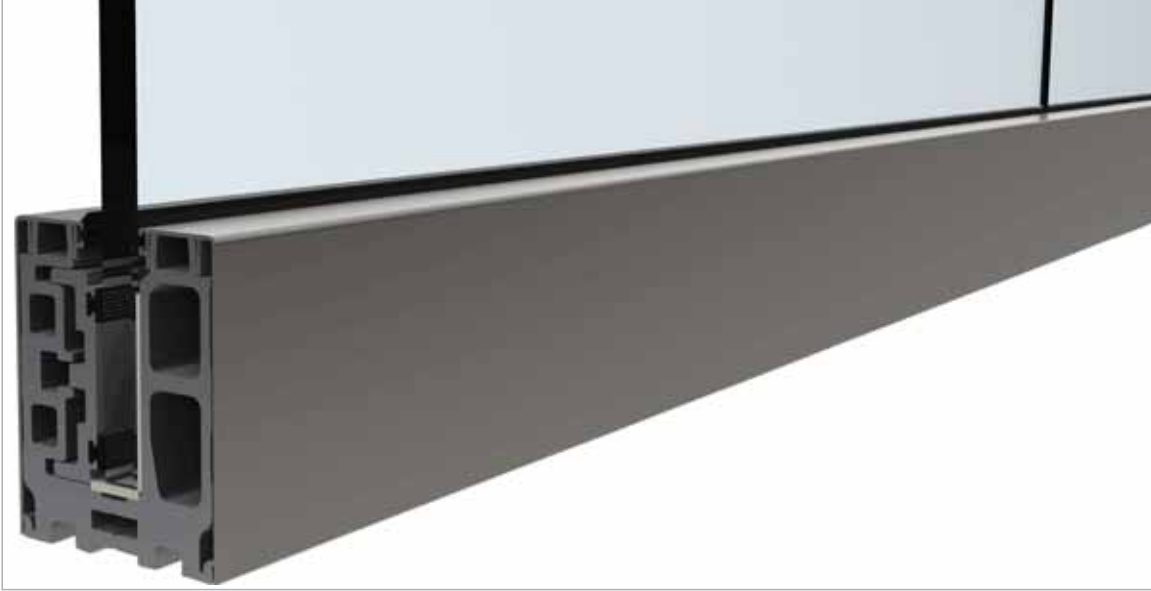

Type A

The Glass Balustrade

Glass H. Max 110 cm
 With 10+10+0,76/1,52 glass
 Weight volume 300 kg/linear meter
 Availability for partial using (15 cm/20 cm)
 Easy installation
 Clamp cover with anodize finishing and RAL
 colour options
 Certificated system

Cam yüksekliği max 110 cm
 Max cam kalınlığı 10+10+0,76/1,52
 Yük kapasitesi 300 kg/metre
 Parçalar halinde kullanabilme (15 cm/20 cm)
 Montaj kolaylığı
 Eloksal ve RAL renk seçenekleri
 Sertifikalı onaylı ürün

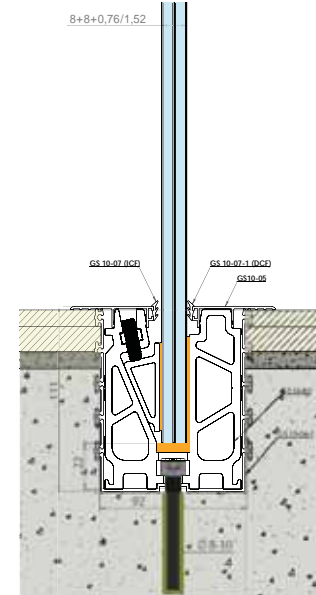
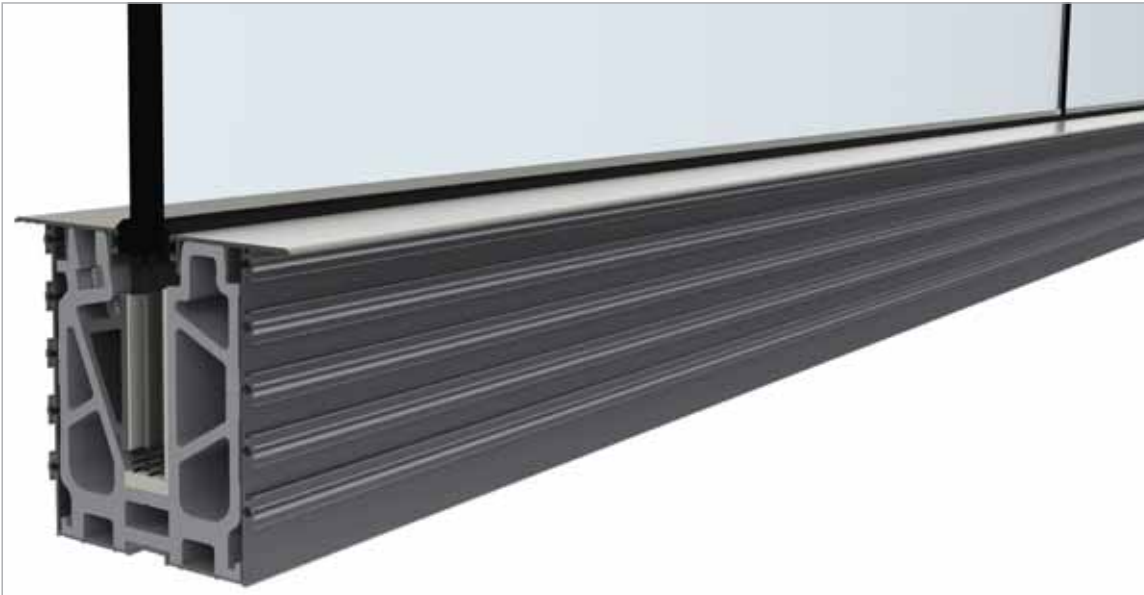

Type B

The Glass Balustrade

Glass H. Max 110 cm
 With 8+8+0,76/1,52 glass
 Weight volume 300 kg/linear meter
 Availability for partial using (15 cm/20 cm)
 Easy installation
 Clamp cover with anodize finishing and RAL
 colour options
 Certificated system

Cam yüksekliği max 110 cm
 Max cam kalınlığı 8+8+0,76/1,52
 Yük kapasitesi 300 kg/metre
 Parçalar halinde kullanabilme (15 cm/20 cm)
 Montaj kolaylığı
 Eloksal ve RAL renk seçenekleri
 Sertifikalı onaylı ürün

Type C

The Glass Balustrade

Glass H. Max 110 cm
With 10+10+0,76/1,52 glass
Weight volume 300 kg/linear meter
Availability for partial using (15 cm/20 cm)
Easy installation
Clamp cover with anodize finishing and RAL colour options
Certificated system

Cam yüksekliği max 110 cm
Max cam kalınlığı 10+10+0,76/1,52
Yük kapasitesi 300 kg/metre
15-20 cm parça olarak kullanabilme
Montaj kolaylığı
Eloksal ve RAL renk seçenekleri
Sertifikalı onaylı ürün

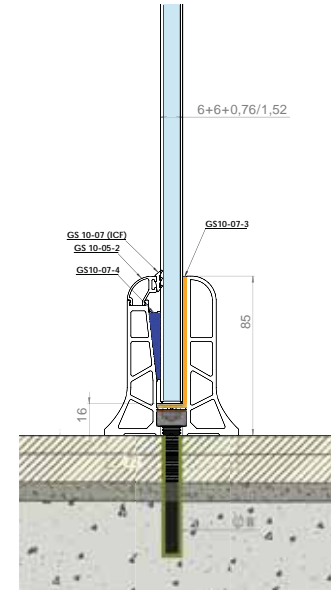
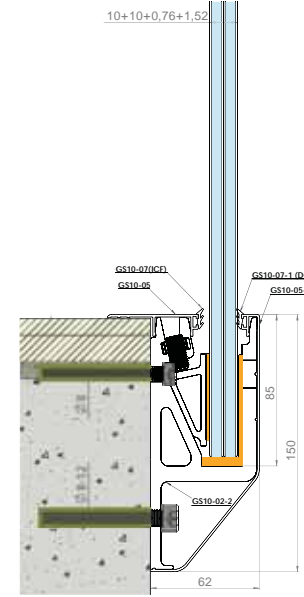
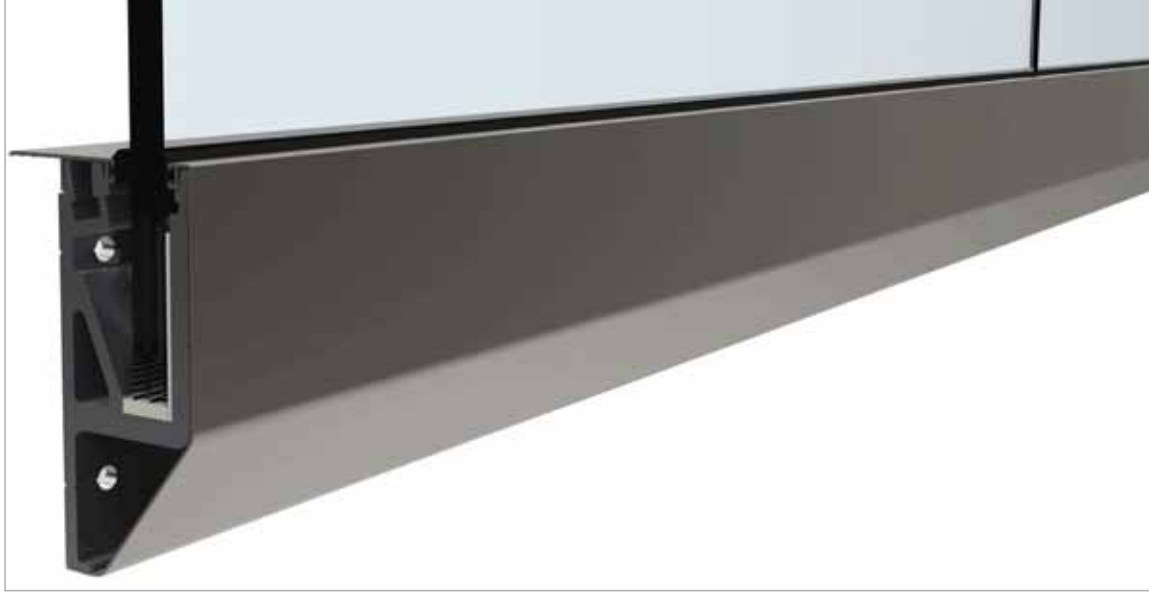

Type F

The Glass Balustrade

Glass H. Max 100 cm
With 6+6+0,76/1,52 glass
Weight volume 150 kg/linear meter
Line profile system
Easy installation
With anodize finishing and RAL colour options
Certificated system

Cam yüksekliği max 100 cm
Max cam kalınlığı 6+6+0,76/1,52
Yük kapasitesi 150 kg/metre
Boy profil olarak kullanabilme
Montaj kolaylığı
Eloksal ve RAL renk seçenekleri
Sertifikalı onaylı ürün

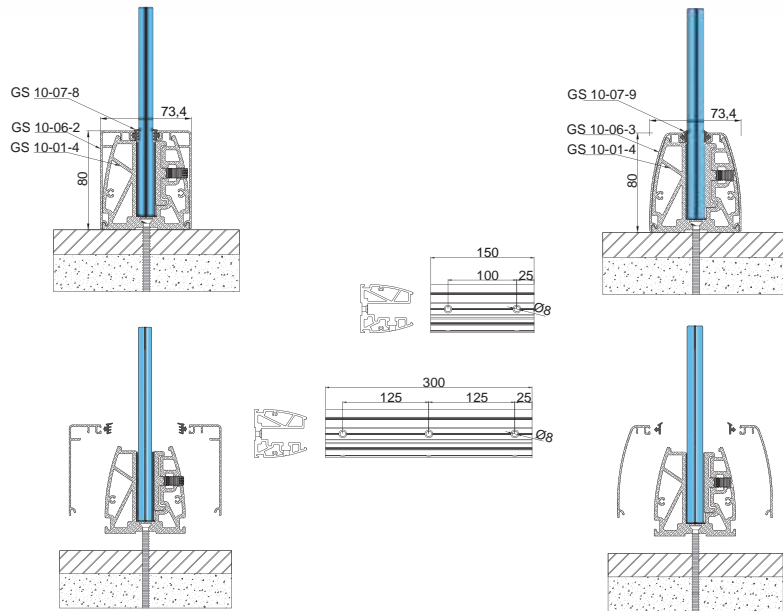
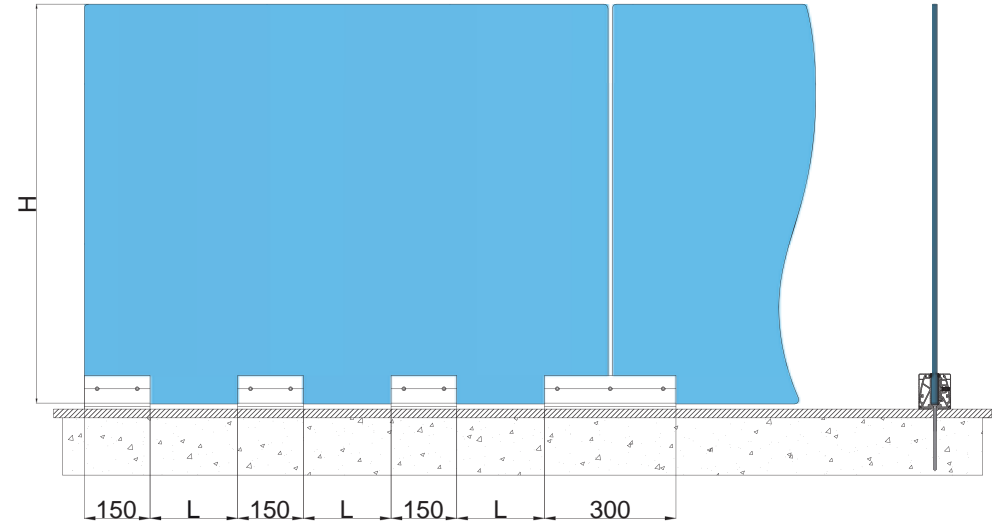
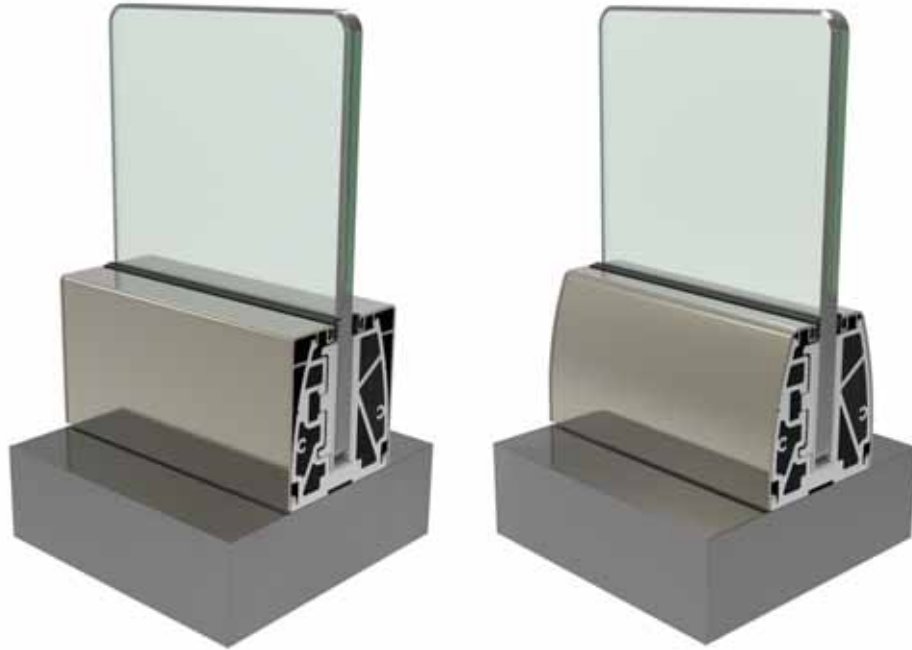

Cam Yüksekliği/H Glass Height/H Hauteur Verre/H (H) ارتفاع الزجاج	Kalınlık (mm) Thickness (mm) Épaisseur (mm) مواصفات و سماكة الزجاج (MM)	L	(kN)	(J)
0-599 mm	(5+1,52+5),(6+1,52+6)	400 mm	-	-
600-899 mm	(5+1,52+5),(6+1,52+6)	350 mm	-	-
900-1099 mm	(5+1,52+5),(6+1,52+6)	250 mm	-	-
1100-1200 mm	(5+1,52+5),(6+1,52+6)	200 mm	-	-

*Bina yüksekliğine göre kullanılacak cam kalınlığı ve ürün aralığı değişiklik gösterebilir.

*Depending on the building's height the measurements and standards may change

*Les épaisseurs de verre et les entraxes peuvent varier selon la hauteur du bâtiment.

من الممكن أن تتغير المسافة ومواصفات الزجاج اعتماداً على ارتفاع المبنى والطابق المراد استخدام هذا النموذج له *

Cam Kanal Sistem Küpeşte Uygulama Detayları

Glass Channel System Railing Application Details

GS 50

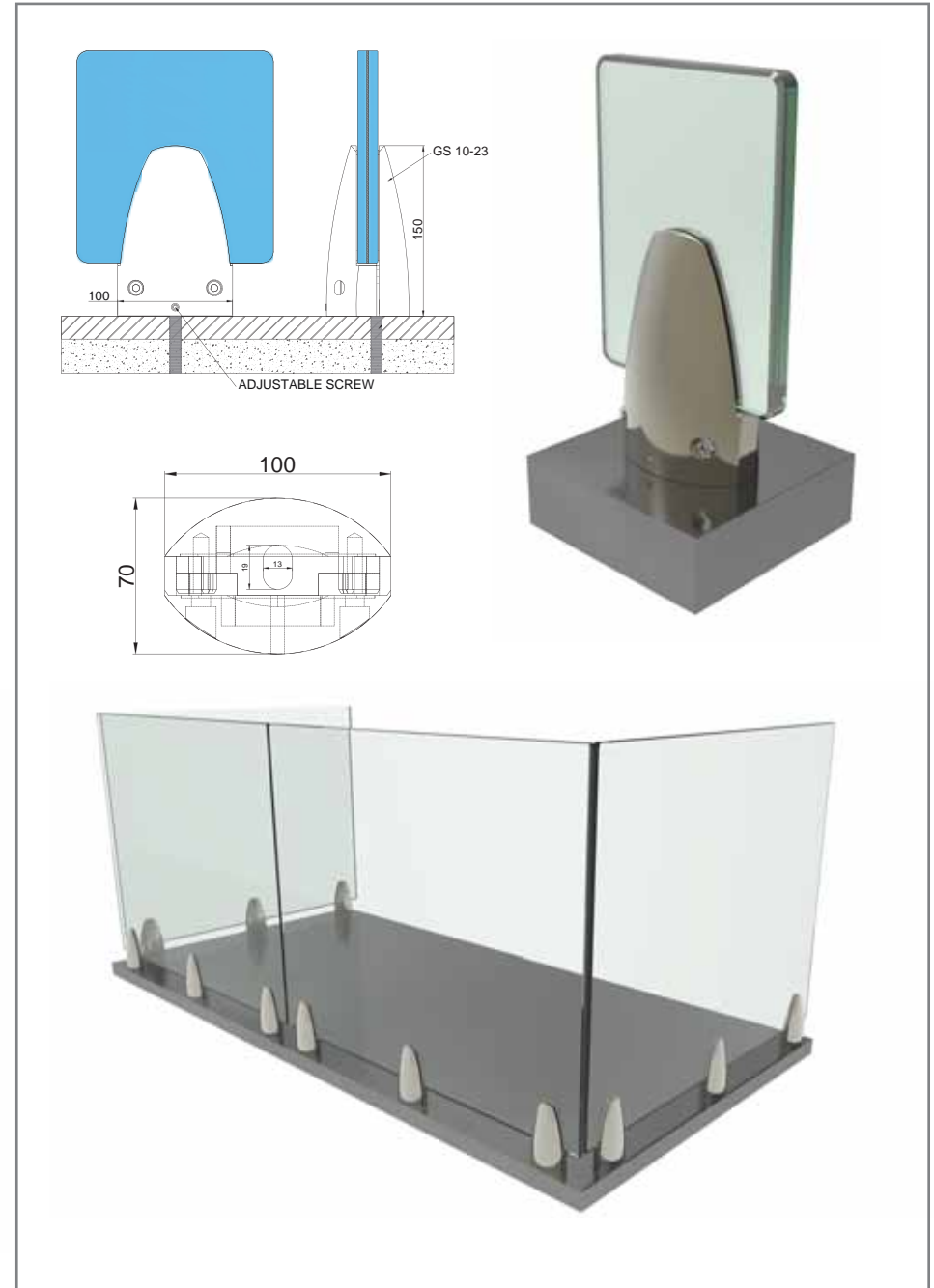
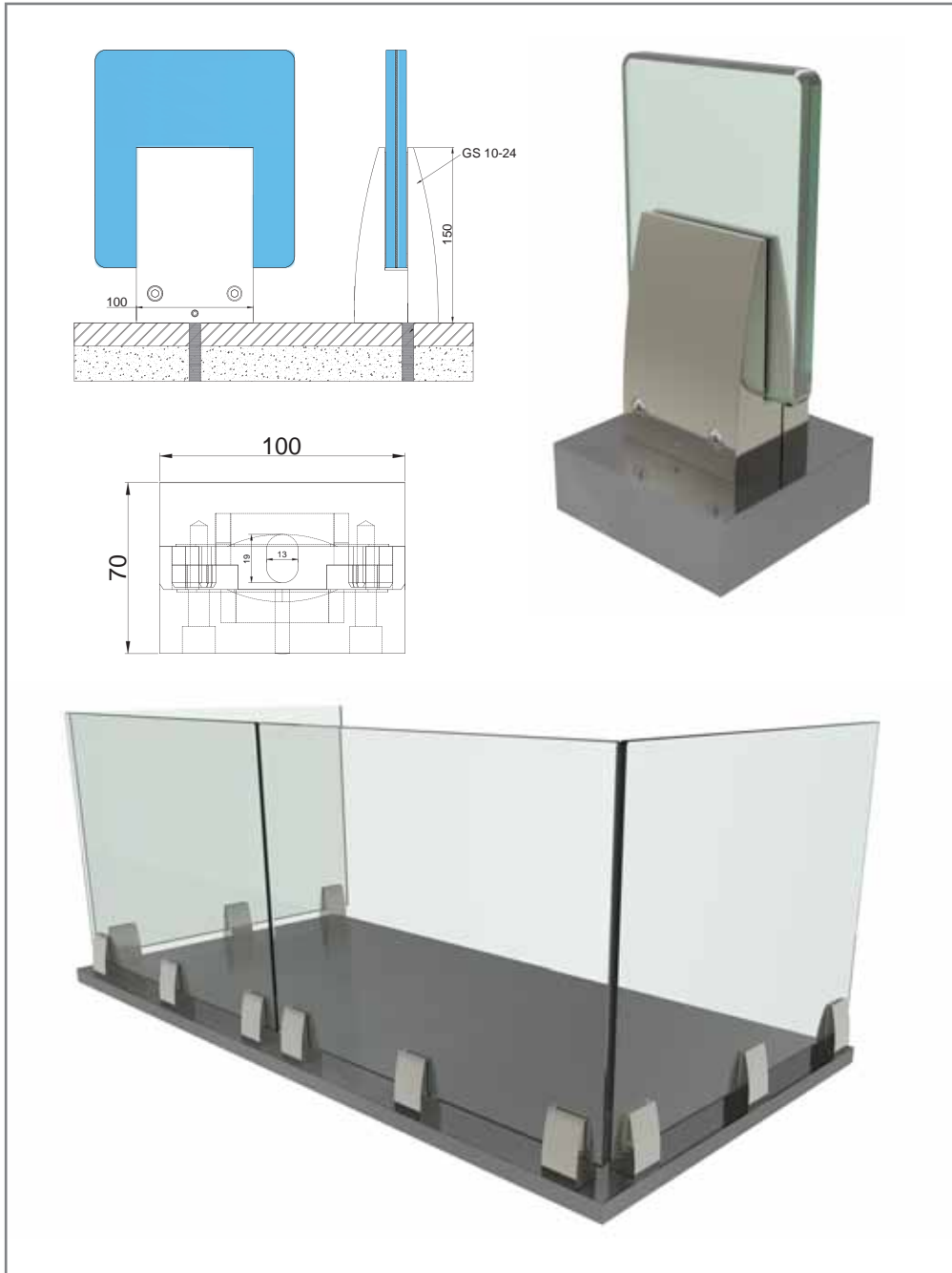

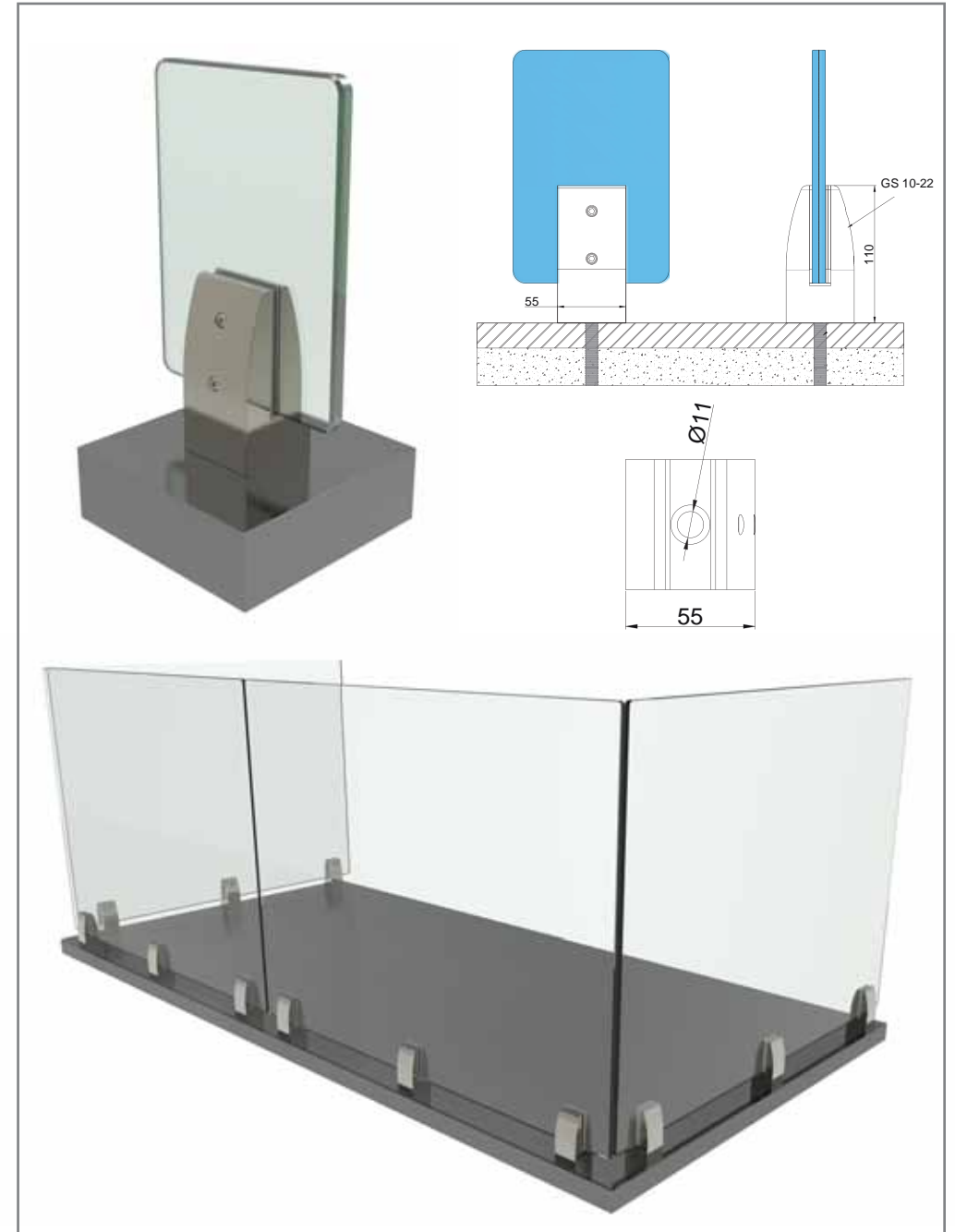
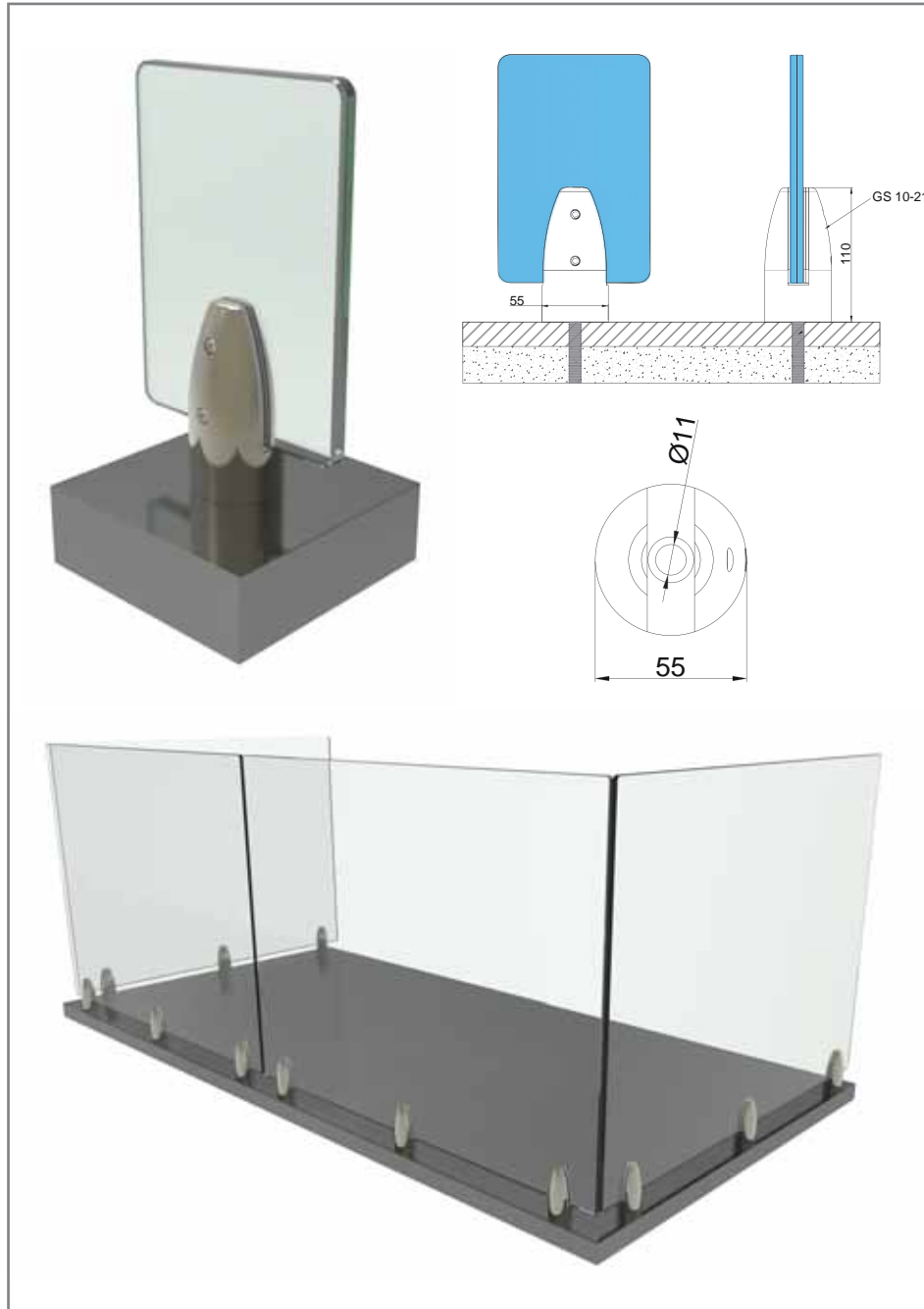

Cam Kanal Sistem K peŐte Uygulama Detayları

Glass Channel System Railing Application Details

GS 50

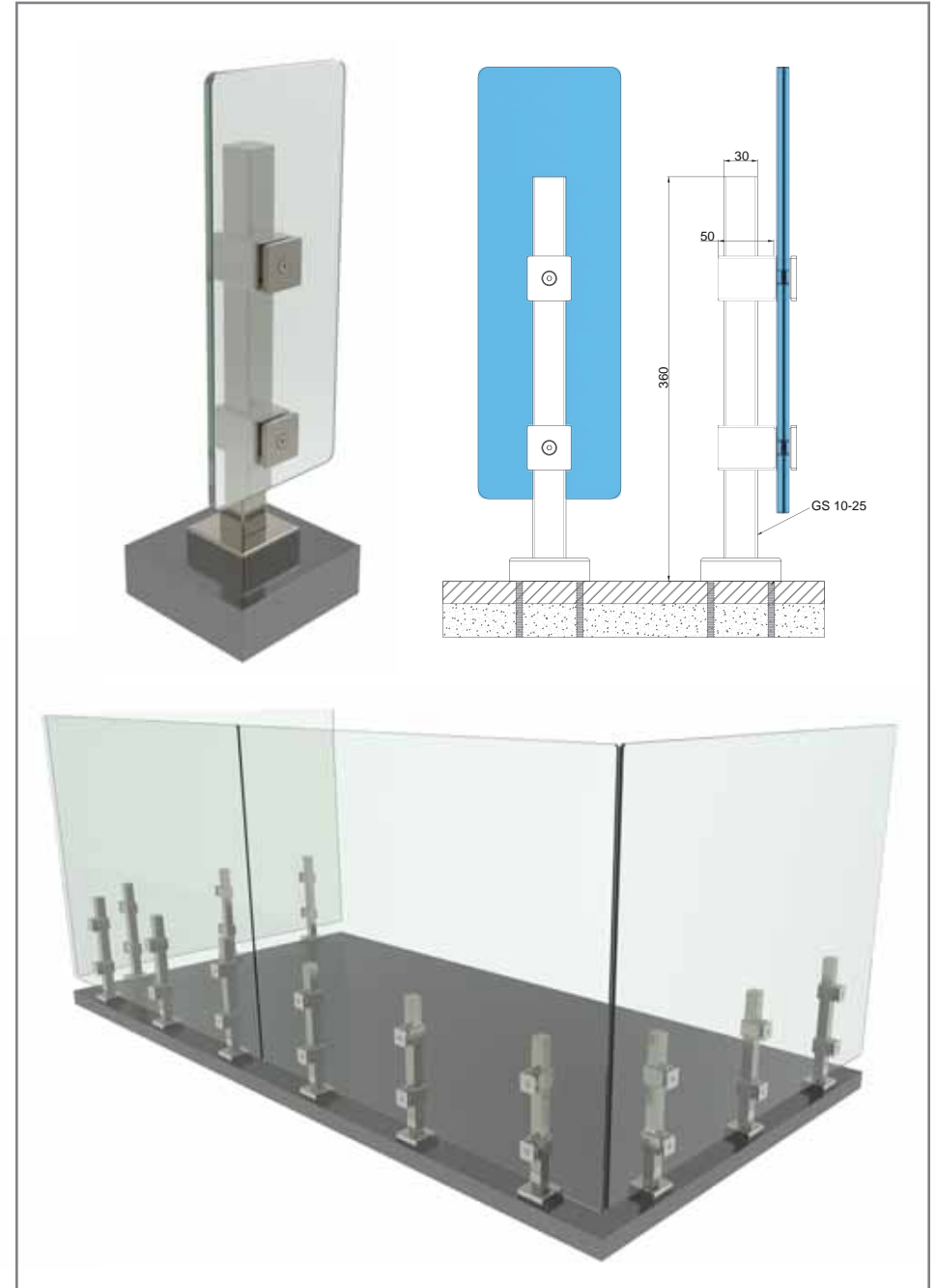
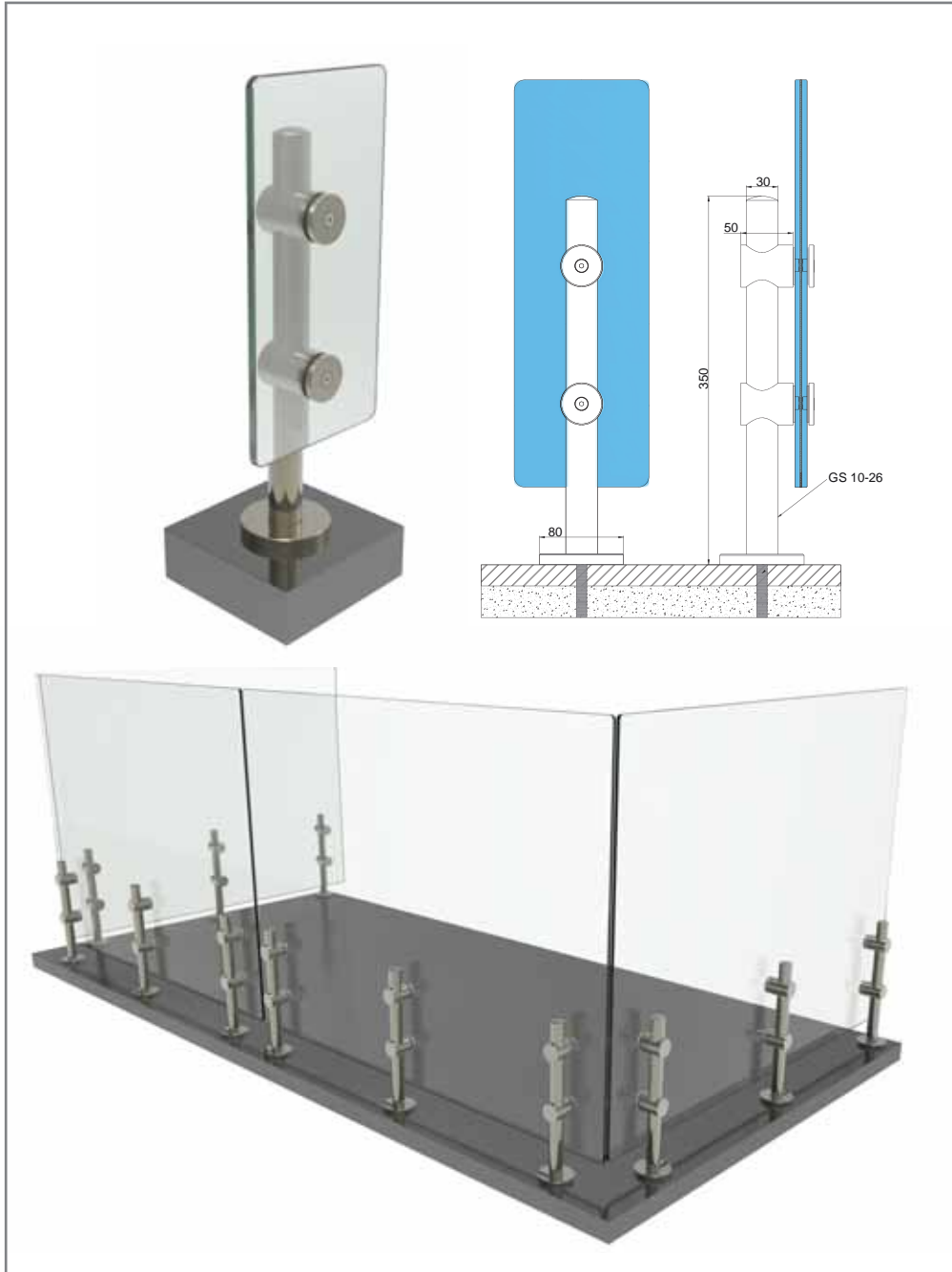

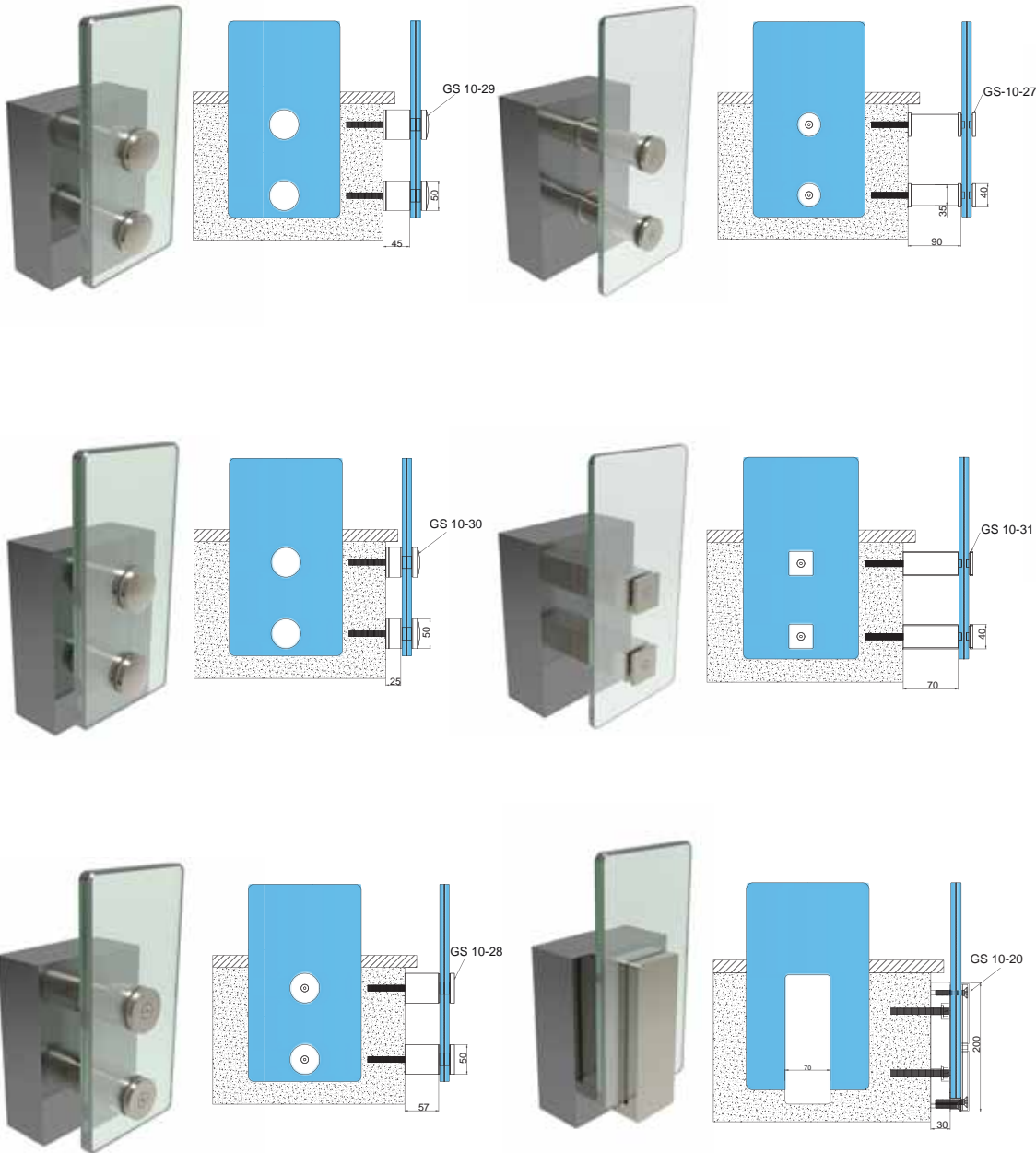

Cam Yüksekliği/H Glass Height/H Hauteur Verre/H (H) ارتفاع الزجاج	Kalınlık (mm) Thickness (mm) Epaisseur (mm) مواصفات و سماكة الزجاج (MM)	L	(kN)	(J)
0-599 mm	(5+1,52+5),(6+1,52+6)	1150 mm	-	-
	(8+1,52+8),(10+1,52+10)	1250 mm	-	-
600-899 mm	(5+1,52+5),(6+1,52+6)	1100 mm	-	-
	(8+1,52+8),(10+1,52+10)	1200 mm	-	-
900-1099 mm	(5+1,52+5),(6+1,52+6)	1000 mm	-	-
	(8+1,52+8),(10+1,52+10)	1100 mm	-	-
1100-1200 mm	(5+1,52+5),(6+1,52+6)	900 mm	-	-
	(8+1,52+8),(10+1,52+10)	1000 mm	-	-

*Bina yüksekliğine göre kullanılacak cam kalınlığı ve ürün aralığı değişkenlik gösterebilir.

*Depending on the building's height the measurements and standards may change

*Les épaisseurs de verre et les entraxes peuvent varier selon la hauteur du bâtiment.

من الممكن أن تتغير المسافة ومواصفات الزجاج اعتماداً على ارتفاع المبنى والطابق المراد استخدام هذا الموديل له *

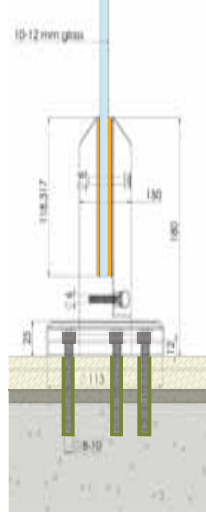

Type G

The Glass Balustrade

Glass H. Max 110 cm
With 10-12 mm glass
Class 150 kg/linear meter
Set part system
Easy installation
With anodize finishing and RAL colour options

Cam yüksekliği max 110 cm
Max cam kalınlığı 10-12 mm
Yük kapasitesi 150 kg/metre
Set olarak kullanılabilme
Montaj kolaylığı
Eloksal ve RAL renk seçenekleri

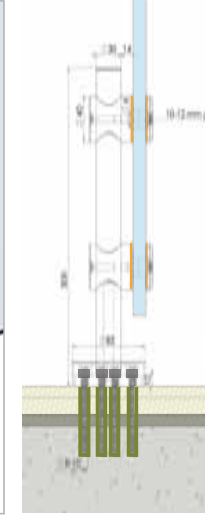

Type H

The Glass Balustrade

Glass H. Max 100 cm
With 10-12 mm glass
Class 150 kg/linear meter
Set part system
Easy installation
With anodize finishing and RAL colour options

Cam yüksekliği max 100 cm
Max cam kalınlığı 10-12 mm
Yük kapasitesi 150 kg/metre
Set olarak kullanılabilme
Montaj kolaylığı
Eloksal ve RAL renk seçenekleri

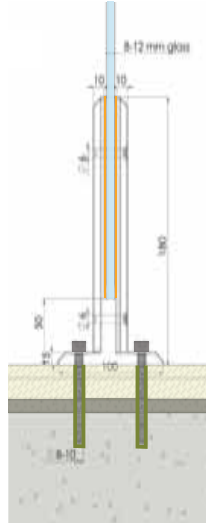

Type I

The Glass Balustrade

Glass H. Max 110 cm
With 10-12 mm glass
Class 150 kg/linear meter
Set part system
Easy installation
With anodize finishing and RAL colour options

Cam yüksekliği max 110 cm
Max cam kalınlığı 10-12 mm
Yük kapasitesi 150 kg/metre
Set olarak kullanılabilme
Montaj kolaylığı
Eloksal ve RAL renk seçenekleri

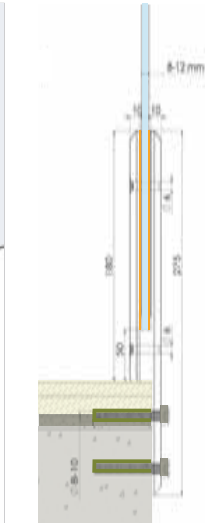

Type J

The Glass Balustrade

Glass H. Max 110 cm
With 10-12 mm glass
Class 150 kg/linear meter
Set part system
Easy installation
With anodize finishing and RAL colour options

Cam yüksekliği max 110 cm
Max cam kalınlığı 10-12 mm
Yük kapasitesi 150 kg/metre
Set olarak kullanılabilme
Montaj kolaylığı
Eloksal ve RAL renk seçenekleri

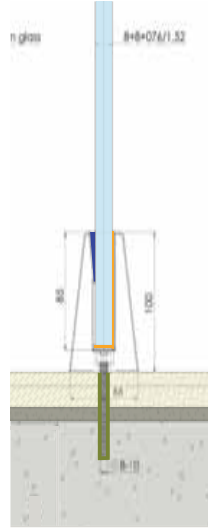

Type K The Glass Balustrade

Glass H. Max 110 cm
With 8+8+0,76/1,52 glass
Class 250 kg/linear meter
Set part system
Easy installation
With anodize finishing and RAL colour options

Cam yüksekliği max 110 cm
Max cam kalınlığı 8+8+0,76/1,52 mm
Yük kapasitesi 250 kg/metre
Set olarak kullanabilme
Montaj kolaylığı
Eloksal ve RAL renk seçenekleri

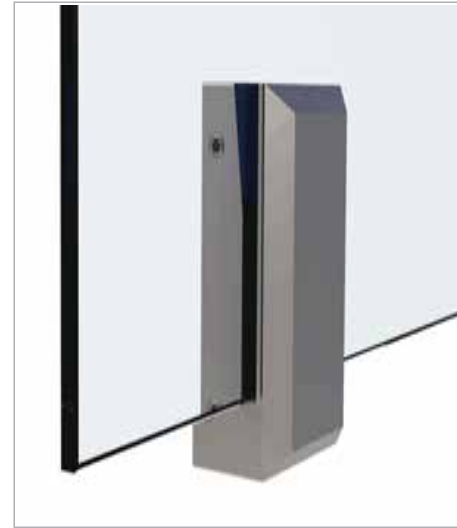

Type L The Glass Balustrade

Glass H. Max 100 cm
With 10-12 mm glass
Class 150 kg/linear meter
Set part system
Easy installation
With anodize finishing and RAL colour options

Cam yüksekliği max 100 cm
Max cam kalınlığı 10-12 mm
Yük kapasitesi 150 kg/metre
Set olarak kullanabilme
Montaj kolaylığı
Eloksal ve RAL renk seçenekleri



Type M The Glass Balustrade

Glass H. Max 110 cm
With 10-20 mm glass
Class 100 kg/linear meter
Set part system
Easy installation
With anodize finishing and RAL colour options
Certificate system

Cam yüksekliği max 110 cm
Max cam kalınlığı 10-20 mm
Yük kapasitesi 100 kg/metre
Set olarak kullanabilme
Montaj kolaylığı
Eloksal ve RAL renk seçenekleri



Type N The Glass Balustrade

Glass H. Max 110 cm
With 10-20 mm glass
Class 100 kg/linear meter
Set part system
Easy installation
With anodize finishing and RAL colour options
Certificate system

Cam yüksekliği max 110 cm
Max cam kalınlığı 10-20 mm
Yük kapasitesi 100 kg/metre
Set olarak kullanabilme
Montaj kolaylığı
Eloksal ve RAL renk seçenekleri

